



SLIDING SCREEN FITTING INSTRUCTIONS – SL3F

Sliding door guide block installed on site

Components: SFK-SL3F

- 1 x **Bag 1** – small & large hex keys
- 1 x **Bag 11** – packers
- 1 x **Bag 114 SL** – adjusting block & M6x35 bolt & nut
- 2 x **Bag 111** – End connector channel
- 1 x Handles Set 'NF' SL
- 1 x Roller Set
- 1 x Clear Silicon
- 1 x Blue Masking Tape
- 1 x Bumper Pack (6)
- 1 x BAG-GB-W
- 1 x BAG-GB-B
- 1 x Screen Fitting Instructions

Checked by: _____

Date: _____

Other equipment required:

- No 1 Square Drive Screwdriver
- Phillips Screwdriver
- Caulking Gun
- Drill
- Level
- Pencil
- Tape Measure

Included with this shower package:

- | | | | |
|---|--------------------------|--|--------------------------|
| 1 x Glass Door with 2 large holes - SL B | <input type="checkbox"/> | 1 x Glass receiver channel – WCT | <input type="checkbox"/> |
| 1 x Plain Fixed Panel - SL F | <input type="checkbox"/> | Components below included in WCT: | |
| 1 x Top Rail Brace – TRB-SL | <input type="checkbox"/> | 1x Bag18 – 8x6Gx40 Sq drive screws & wall plugs – 1x4mm drill bit | <input type="checkbox"/> |
| | | 1 x Vertical Seal – SEAL-BULB | <input type="checkbox"/> |

DO NOT INSTALL DAMAGED OR DEFECTIVE PRODUCTS

- It is the installer's responsibility to thoroughly check the glass panel prior to installation.
- Atlantis will take no responsibility for any glass panel that has been installed with a noticeable defect.

NOTE: a noticeable defect must be visible to the naked eye, in normal daylight conditions, standing at a distance of two meters.

Any imperfection that is not visible within the above noted parameters will not be accepted by Atlantis to be a defective product, and installation can proceed as usual.

***PLEASE NOTE:** Stand glass upright at all times. Keep glass panels level with the floor to avoid damaging corners.*

NO RESPONSIBILITY WILL BE TAKEN BY ATLANTIS FOR ANY GLASS BREAKAGES OR CHIPPED EDGES.

GLASS RECEIVER CHANNEL MUST BE INSTALLED ONTO THE WATERPROOFING BEFORE THE WALLS ARE TILED



Installer – When Architectural Finish is fitted to base. Trim the internal leg off the wall channel to adequately clear the base surface. Ensure the wall channel interlocks correctly with the base.

1. Choose door direction.

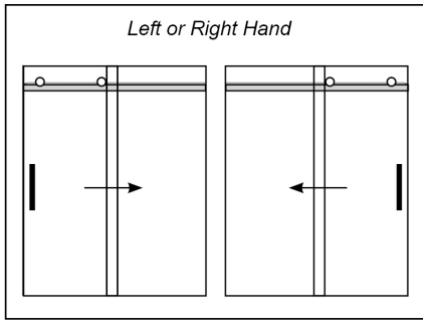

2. **1 x Glass Receiver Channel**

Position the glass receiver channel over the base glazing channel. The channel will be located on the fixed panel side only. Use a straight edge and mark the wall to indicate where the wall channel is plumb.

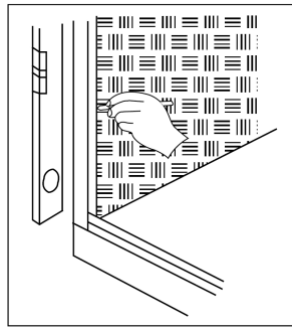

3. Apply a silicon seal to full length of channel.

Silicon used must be compatible with anodised aluminium as well as the waterproofing being used.

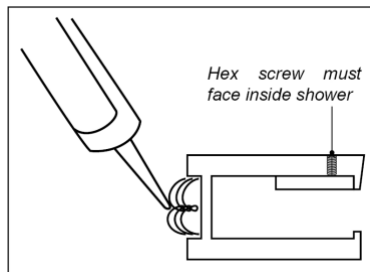

4. Ensure the glass receiver channel is located firmly over the base glazing channel. The machine recess in the wall glazing channel must firmly locate over the base glazing channel.

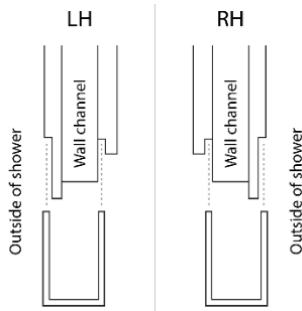

5. Locate the framing timber. Use the 4mm drill bit to drill holes through the glass receiver channel. Fix four screws through the channel in the wall framing (use wall plugs if required).

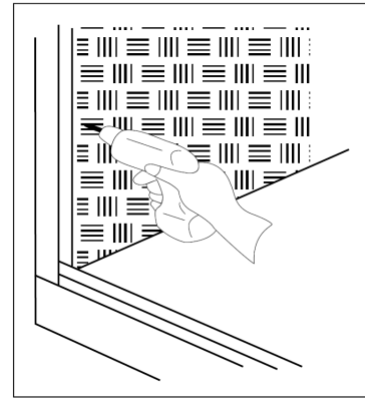

6. Apply a continuous bead of silicon to the full length of the channel and waterproofing, indicated by the dark line (inside channel).

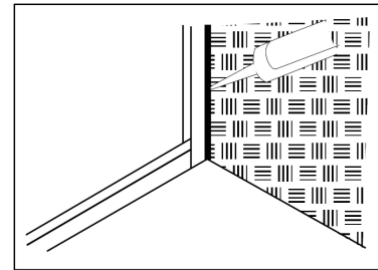

7. **INSTALLATION OF TOP RAIL BRACE END CONNECTOR CHANNELS AND SPACER**

Fix the first top rail brace end connector channel and spacer 120mm from the top of the glass receiver channel as shown. *Detail shown below. Must be accurate.* 120mm from top of wall channel to top of end connector channel.

Fig. 1

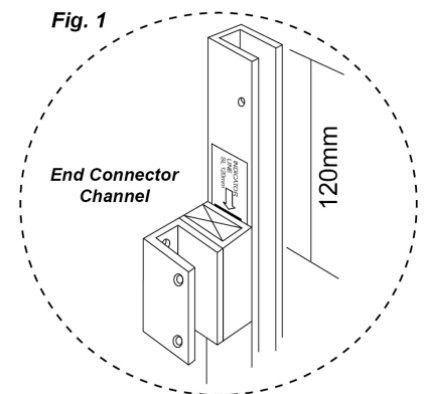

8. INSTALLATION OF SECOND END CONNECTOR CHANNEL

Carefully mark out and position the second end connector channel directly to the waterproofing. Ensure the two top rail brace end connector channels are level to each other and parallel to the base glazing channel.

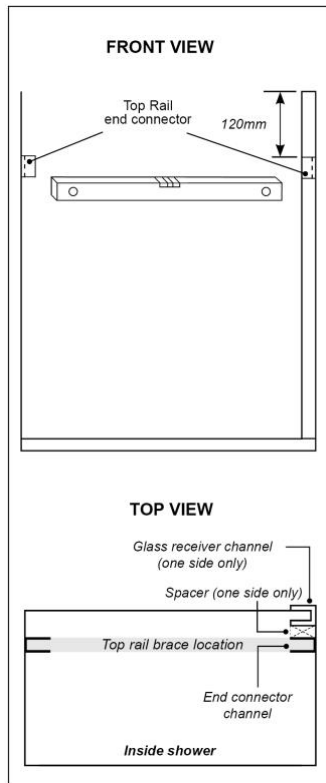

9. TOP RAIL BRACE INSTALLATION

It is recommended that the top rail brace is fitted prior to tiling. AVOID SCRATCHING.

Trim to length if necessary. Slide into the end connector channels.

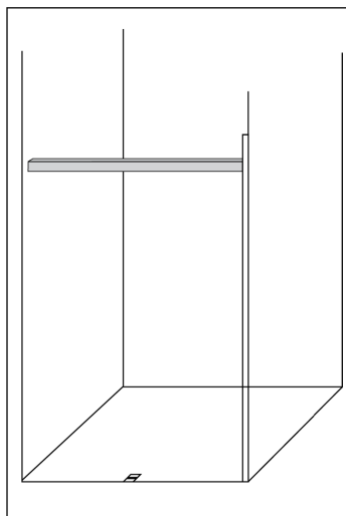

Door Stop/Adjusting Block

The hole for the adjusting block should be positioned towards the top of the bar, facing out to connect to fixed glass panel.

Drill into CSK holes provided in end connector channel. Fix with the short CSK screws.

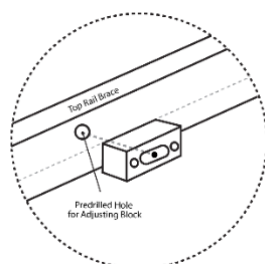

10. HANDLE INSTALLATION

Assemble handles as shown. Use the 3mm Hex Key supplied with handle set.

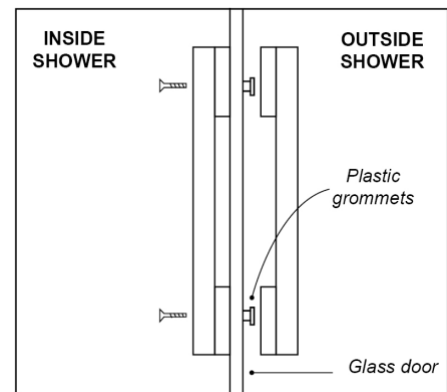

11. ROLLER SET ASSEMBLY TO GLASS DOOR

Ensure the direction of the door is correct. Fit the plastic grommet through the glass first (note direction of grommet). Tighten with the 4mm Hex Key supplied.

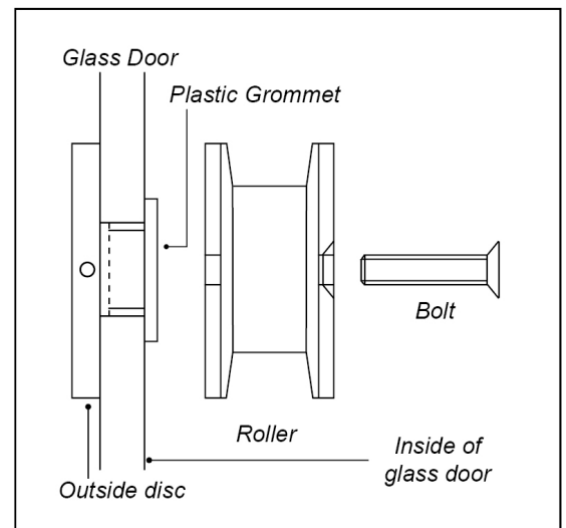

12. Protect the top rail brace outside face with the blue tape supplied.

Stand outside the shower. Lift the door, SL B and place rollers onto the top rail brace. At the same time locate the door into the bottom door guide. Adjust the door height and alignment by loosening the roller bolts and rotating the outside disc. Ensure the bottom of the door clears the floor tiles.

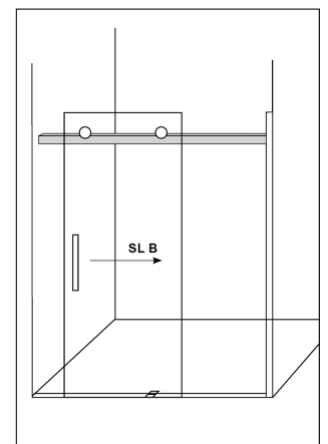

13. PREPARATION FOR GLASS INSTALLATION

Apply plastic packers into the base glazing channels in locations as shown.

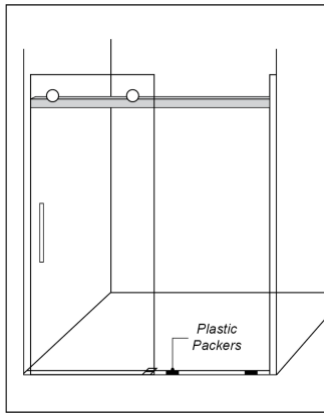

14. CRITICAL SEAL

Remove dust and dirt first. Seal the connection between the glass receiver channel and the base glazing channel with clear silicon, prior to the installation of panel **21 B**.

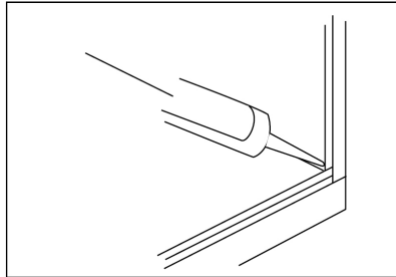

15. INSTALLATION OF FIXED PANEL

Locate the glass panel into the glazing channel. Add or remove packers in the base glazing channel as necessary.

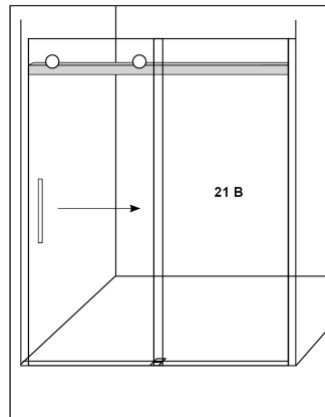

16. ADJUSTING BLOCK

Apply the plastic grommets into the holes in the glass panel **HZ-F**. Assemble retainer plate as shown.

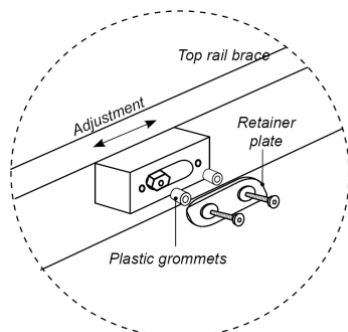

17. DOOR OPENING SILL INFILL

Trim Sill Infill to fit between the fixed panel and wall. Apply a continuous bead of clear silicon to each inside face of the base channel. Ensure the ends of the Sill Infill are sealed and place into the base channel in the location as shown.

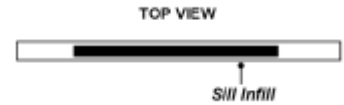

Apply a generous quantity of silicone at either end of the sill infill prior to final glass placement.

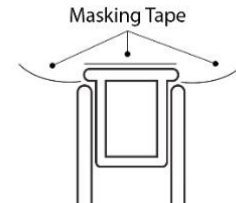

18. SLIDING DOOR GUIDE BLOCK

There are two options when installing a guide block. In each case ensure the guide block isn't too tight (must allow the glass to slide through it). Apply a small bead of silicon to the bottom and side of the block and then place into position – tight to the inside of the glazing channel. Use a 1 or 2mm packer on the outside of the glass to firmly hold the glass and guide block in place. Tape glass and block into place to ensure they don't move while silicon cures.

Guide Block Fitted Prior to Tiling

BASE LENGTH (L)	DISTANCE (X)
1500	785
1600	885
1700	985
1800	1085
1900	1185
2000	1285

For RH Fixed Panel

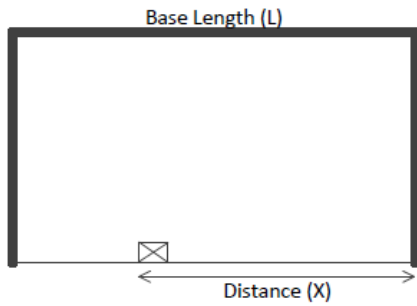

For LH Fixed Panel

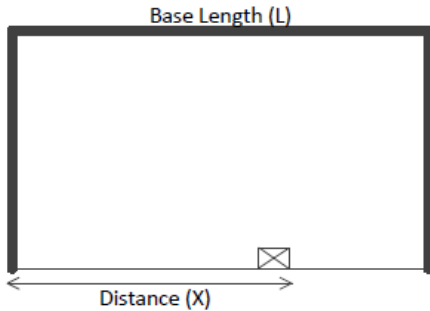

Guide Block Fitted after Tiling or on an Architectural Finish

Slide the door as far back in an open position as possible (be careful of it hitting the wall). Slip the sliding guide block under the door and locate it in line with the end of the fixed panel on the opening side. Ensure that the door is level. Silicone into place

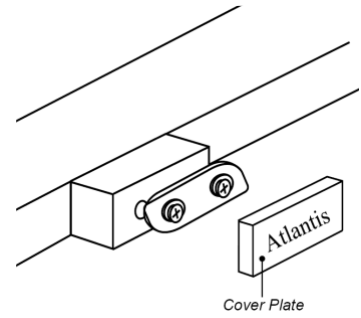
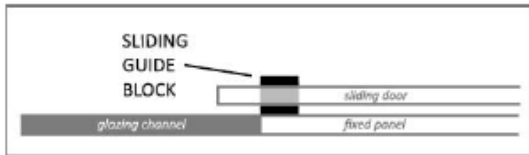

21. SILICON APPLICATION

Using the blue tape supplied, mask the glazing channel and glass at the intersections as shown. Apply clear silicon to the inside and outside of the glass panel. Use the spatula provided to remove provided to remove the excess silicon. Remove the masking tape immediately after application.

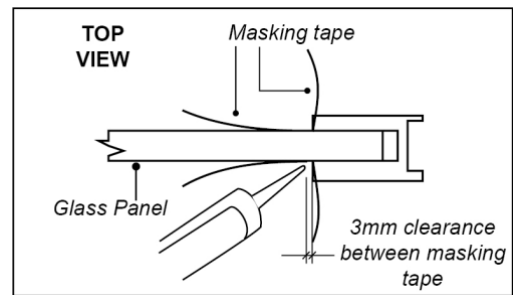

19. FASTENING GLASS

Secure the glass panel into the receiver channel by tightening hex screws firmly with hex key supplied. **(Do not overtighten).**

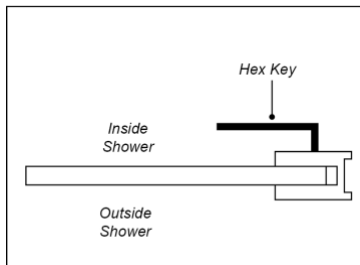

20. ADJUSTING BLOCK COVERS

Apply clear silicon to the heads of the screws and place the cover plate over the end retainer plate. Tape in place for 24 hours.

22. BUMPER APPLICATION

Apply 15mm area of primer to wall tiles and adjusting block in locations as shown by the dark dots. Place bumpers onto primer. Ensure the door slides to, and meets the centre of the bumpers. Alternatively use vertical seal supplied on leading edge of door.

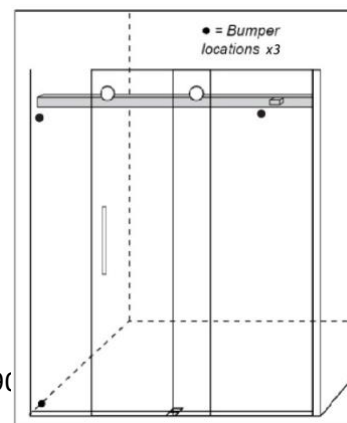



SLIDING SCREEN – GUIDE BLOCK

CODE - ABS-LQ-GB-LONG

Linea Quattro – Installed on base prior to tiling

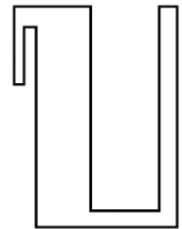

CODE - ABS-LQ-GB-SHORT

Linea Quattro – Installed after tiling or on an Architectural Finish when installing screens



CODE - ABS-EI-GB-WHITE / BLACK

Ebony & Ivory – Installed on base when installing screens

